

Warranty: If this unit fails during the warranty period, contact tii customer service to authorize return. Unit may be returned prepaid.

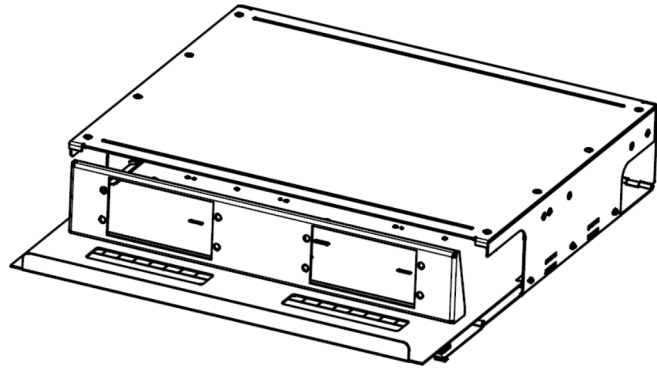

141 Rodeo Drive
Edgewood, NY 11717
Toll Free 888.844.4720
www.tiitech.com



Model RM2U4B
RACKMOUNT DISTRIBUTION PANEL

Installation Note

Description

The RM is a Rack mount Distribution Enclosure which fits both 19" and 23" Racks. It can be Factory loaded with Adapter Plates, Splice Trays and Pigtails in 250/900um or 12 Fiber Ribbon Cable.

Contents

- RM Series Rack mount Panel
- 19/23" Mounting Brackets
- Cable entry clamp
- Screws

Features

- 19 or 23" Rack Mountable
- Up to 4 LGX118 Adapter Plates or Cassettes
- Master Tray slides out front and rear
- Multiple Tie Down Points for Buffer Tube
- Cable Management with Fan out Kit Securing Points

Installation

1. Secure either 19" or 23" Rack mount ears to panel using supplied screws
2. Position Enclosure at desired location in the Rack. This unit will consume 2RU of space



3. Install cable entry clamp on either left or right rear depending on feeder cable entry using supplied screws
4. Prep the feeder cable for termination per cable manufacturer's instructions, typically 1 meter jacket removal. And pull cable to suitable work surface.



5. Remove master plate from front or rear to assist with fiber routing. Terminate or fusion splice feeder cable. Re install master plate with feeder cable. Store excess feeder in slack storage loop.



6. Secure feeder cable to cable entry clamp using supplied hose clamps or other suitable fastener like a zip-tie.